

TYPHOON®

FIRE SYSTEMS

CONTROL VALVE - Casting





We Care Every Drop of Water...

That is why our company, which has been developing products in the field of water systems for over 20 years, offers increasingly efficient solutions every day. With our expertise and experience, we continue to develop innovative technologies for the proper control and sustainable use of water.

OUR PRODUCTION CAPACITY IS INCREASING! OUR GOALS ARE BIGGER!

We have been wherever there is water since 2004.

Founded in Izmir by Tayfun Yazarođlu, TAYFUR WATER SYSTEMS set out with the belief that water is the source of life. Beginning with the production of hydraulic control valves, this journey has now transformed into a strong and reliable brand offering innovative solutions across a wide range of areas, including irrigation, drinking water, firefighting and industrial systems.

In every project, while determining the direction of water, we are also shaping the sustainable infrastructure of the future. From production to project design, from installation to technical support, we work without compromising on high quality standards, with our state-of-the-art facilities and expert team. We aim to offer our customers not just products, but also trust, continuity and technical excellence.

TYPHOON branded products are developed entirely with our own production capabilities and local engineering expertise. These products stand out not only for their durability, but also for our philosophy of preserving the value of every drop. Thanks to our production processes that comply with international standards and our customer satisfaction-focused approach, we are proud to be recognised as a reliable business partner both domestically and globally.

Today, TAYFUR WATER SYSTEMS, a brand with roots in Izmir, continues on its path with the vision of being a symbol of quality, innovation, and trust wherever water is present.





Agricultural Irrigation Systems

The foundation of efficient agricultural production lies in delivering water at the right time, in the right quantity, and to the right location. Modern agricultural irrigation systems ensure both the efficient use of water resources and an increase in product quality and yield. The solutions developed in this context enable farmers to achieve a sustainable production structure independent of climatic conditions.

At TAYFUR WATER SYSTEMS, with our many years of engineering experience in the field of agricultural irrigation, we manufacture critical components such as hydraulic control valves, suction valves, backwash valves and meters to high quality standards. Each of our products saves energy by increasing the automation capabilities of the systems, prevents water wastage and minimises maintenance requirements. Thus, we offer reliable and long-lasting solutions for both small-scale businesses and large agricultural projects.

The products we develop are designed in accordance with international standards and tested to deliver maximum performance in challenging field conditions. At TAYFUR WATER SYSTEMS, our goal is to provide smart, durable, and sustainable systems for producers who value every drop. Because we believe that by determining the direction of water, we are shaping the future of agriculture.



Industrial Area Systems

Proper water management in industrial facilities is critical to the efficiency and sustainability of production processes. Every application, from pressurised lines to cooling circuits, fire systems to process lines, requires precise control and high durability. Therefore, the performance of equipment used in industrial systems is directly related to facility safety and operational continuity.

At TAYFUR WATER SYSTEMS, we manufacture products that play a critical role in industrial applications, such as hydraulic control valves, backwash valves, vacuum breakers, and meters, to high engineering standards. Our products adapt to harsh working conditions with their high pressure resistance, corrosion resistance, and long service life. By providing complete control over fluid management, they increase energy efficiency in systems and minimise maintenance times.

Designed to comply with international standards, our solutions are trusted across a wide range of applications, from factories to power plants, water treatment facilities to infrastructure projects. At TAYFUR WATER SYSTEMS, our goal is to make industrial water management smarter, safer and more sustainable, providing our customers with the assurance of uninterrupted operations.



Fire Systems

Fire safety is one of the most vital elements of every structure, from industrial facilities to public buildings, infrastructure projects to living spaces. The reliability of the equipment used in these systems is critical not only for the protection of the facility but also for the protection of human life.

As TAYFUR WATER SYSTEMS, we are a company specialising in the production of hydraulic control valves to ensure maximum safety in fire lines. Our products are designed to guarantee the fast, reliable and uninterrupted operation of fire systems. These valves, which stand out for their high pressure resistance, leak-proof performance and long service life, are tested in accordance with international standards and offered with quality assurance.

With our advanced engineering infrastructure and production experience, we produce solutions that can be used safely in various applications, from automatic sprinkler systems to fire pump stations. At TAYFUR WATER SYSTEMS, our goal is not just to manufacture products; it is to be part of systems that make a difference in fire safety, inspire confidence, and protect life.



Filter Automation

Water is a vital resource that must be managed with maximum efficiency during the filtration stage, as it is in many industrial and agricultural processes. Proper automation in filtration systems is critical in terms of energy savings, ease of maintenance, and system continuity. An effective filter automation system determines not only the quality of the water but also the lifespan and efficiency of the entire system.

At TAYFUR WATER SYSTEMS, we offer comprehensive solutions in the field of filter automation. Our products, such as hydraulic control valves, backwash valves and panels, bottom valves, and dirt traps, ensure precise flow management in automatic filter systems. Our products optimise the water filtration process while performing backwashing operations precisely and efficiently. This reduces the risk of clogging in systems, prevents energy losses, and extends maintenance intervals.

All our products stand out with their durable material construction, precise control capability, and long-lasting design. At TAYFUR WATER SYSTEMS, our goal is to provide our customers with smart, reliable, and sustainable automation solutions by maximising efficiency in filtration processes. Because we believe that water purity begins with system safety.

Hydraulic Control Valves

Pressure Reducing Hydraulic Control Valve



Pressure Reducing Hydraulic Control Valves are automatic control valves that reduce the system inlet pressure to the desired level via the pressure reducing pilot mounted on them and maintain this value constant. They ensure stable system operation by continuously balancing the outlet pressure without being affected by changes in flow rate and inlet pressure. The valve automatically closes when the flow stops, protecting the system's safety.

Thanks to its high-precision control capability, it provides optimal pressure management in water distribution networks, industrial facilities, and irrigation systems. The valve automatically opens when the set outlet pressure is exceeded, maintaining pressure balance and increasing system efficiency. Pressure-reducing hydraulic control valves, which can be used in horizontal or vertical positions, provide reliable and precise pressure control in all types of hydraulic applications with their robust construction and long-lasting performance.

Order Information

Please provide the following information in case of order

- Maximum flow rate : m³/h
- Maximum network/operating pressure : bar
- Main pipeline diameter : mm
- Valve connection type
- Maximum valve inlet pressure : bar
- Minimum valve inlet pressure : bar
- Desired outlet pressure : bar

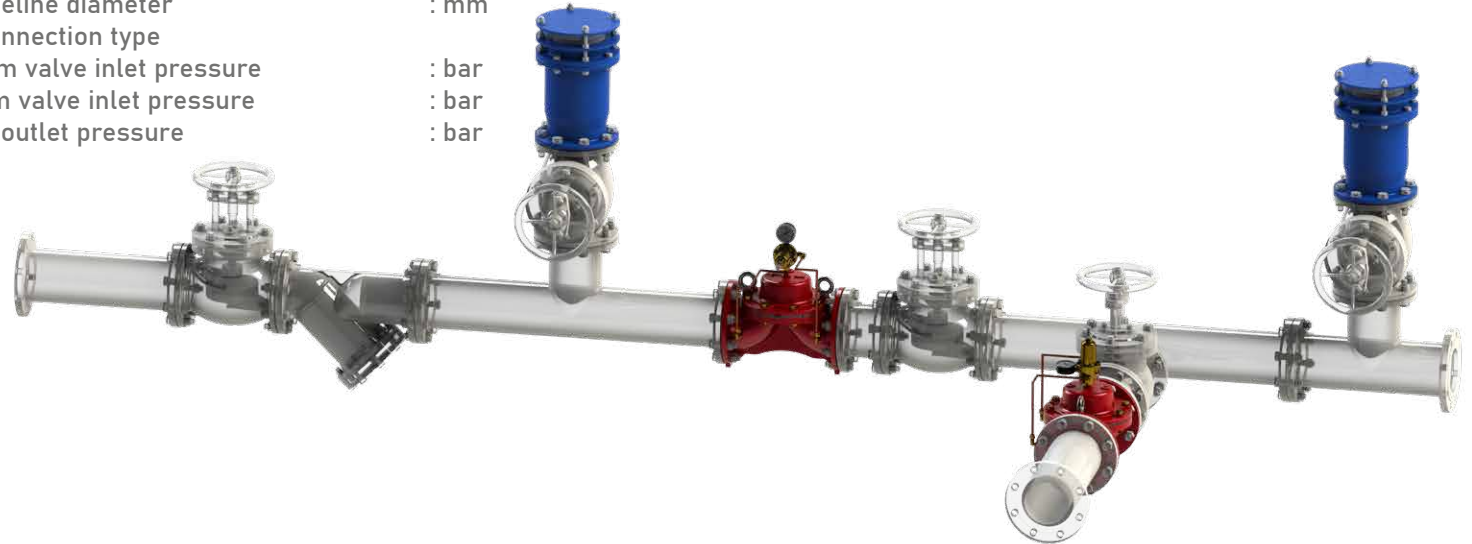

Hydraulic Control Valves

Hydraulic Check Valve



The Hydraulic Check Valve (Backflow Preventer Hydraulic Control Valve) is a hydraulically controlled valve used in place of traditional check valves at pump outlets, automatically preventing backflow. It ensures system safety by precisely sensing changes in flow direction. When the outlet pressure exceeds the inlet pressure, the valve automatically closes itself without creating a water hammer, ensuring system protection.

When the inlet pressure exceeds the outlet pressure, the valve opens slowly and steadily in a controlled manner, ensuring consistent flow. This feature extends the life of system equipment by preventing pressure fluctuations, especially during pump start-up. With their robust construction, high sealing capacity, and quiet operation, Hydraulic Check Valves provide reliable backflow protection and pressure balancing in water supply systems, industrial facilities, and pump stations.

Order Information

Please provide the following information in case of order

- Maximum flow rate : m³/h
- Maximum network/operating pressure : bar
- Main pipeline diameter : mm
- Valve connection type

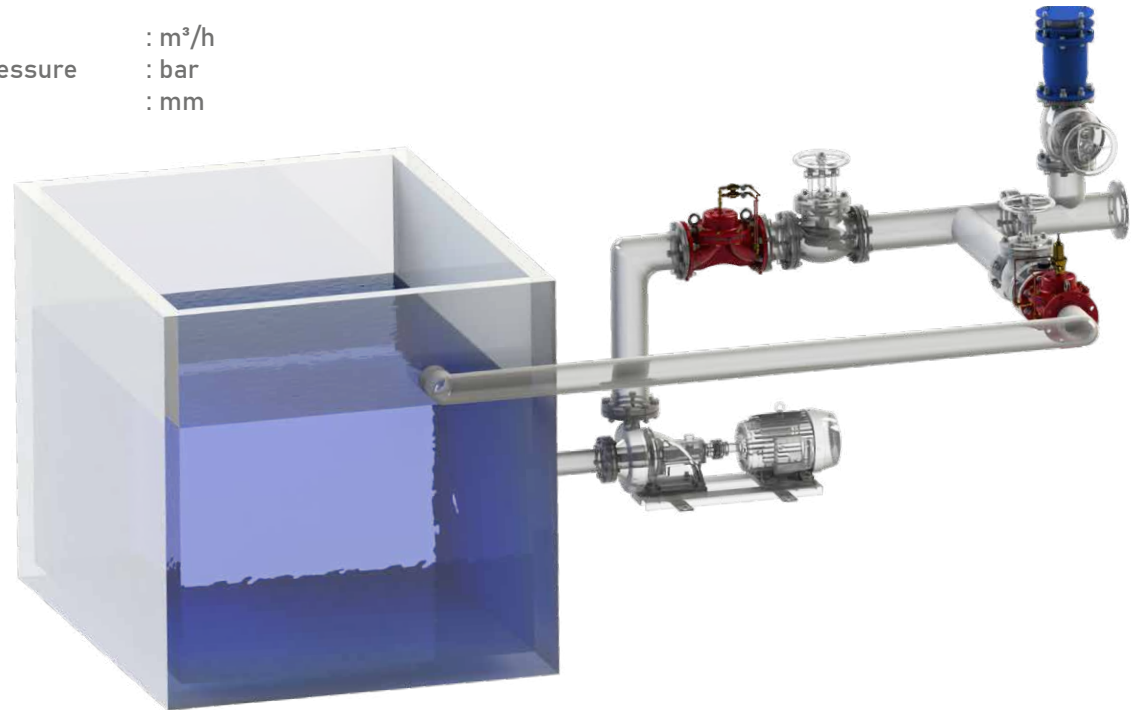

Hydraulic Control Valves

Quick Relief Hydraulic Control Valve



Quick Relief Hydraulic Control Valves are safety valves designed to protect against sudden pressure increases in water systems. The pilot mechanism on the valve allows the inlet pressure to be adjusted to the desired value. When system pressure exceeds a predetermined limit, the valve quickly opens and releases excess pressure, thus preventing damage to equipment in the pipeline.

Thanks to its hydraulically operated design, the sudden opening and closing process is slow and controlled, preventing pressure fluctuations and water hammers in the system. Providing high safety with their fully leak-proof closing feature, Quick Relief Control Valves can be used alone in critical areas of water transmission lines or as safety or warning valves in the outlet lines of pressure-reducing control valves. Their durable body and high response sensitivity contribute to the system's stable, safe, and efficient operation.

Order Information

Please provide the following information in case of order

- Maximum flow rate : m³/h
- Maximum network/operating pressure : bar
- Main pipeline diameter : mm
- Valve connection type
- Maximum valve inlet pressure : bar
- Desired inlet pressure : bar

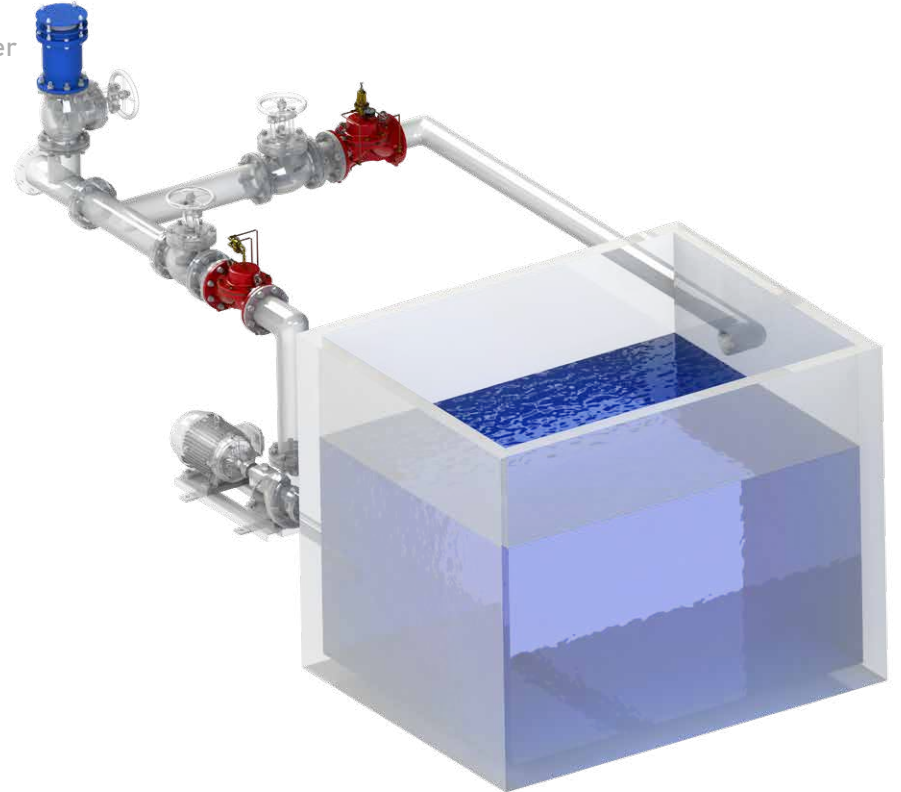

Hydraulic Control *Valves*

Float Level Control Valve



Float Level Control Valves are hydraulically controlled valves that automatically monitor and balance the water level in water tanks. The main valve is manually controlled via the two-way float switch within the system. Mounted at the tank inlet, the valve closes when the water level reaches maximum water level without causing a water hammer, and opens automatically when the level reaches minimum, ensuring the tank remains constantly full. This ensures both water conservation and uninterrupted flow.

A needle valve is used to adjust the valve's opening and closing speed to the desired level. This feature contributes to more precise and balanced system operation. Float Level Control Valves can be installed horizontally or vertically and are compatible with electric float or differential float control systems depending on the application. Their durable construction, leak-proof performance, and long-lasting operation ensure safe level control in water storage and transmission systems.

Order Information

Please provide the following information in case of order

- Maximum flow rate : m³/h
- Maximum network/operating pressure : bar
- Main pipeline diameter : mm
- Valve connection type

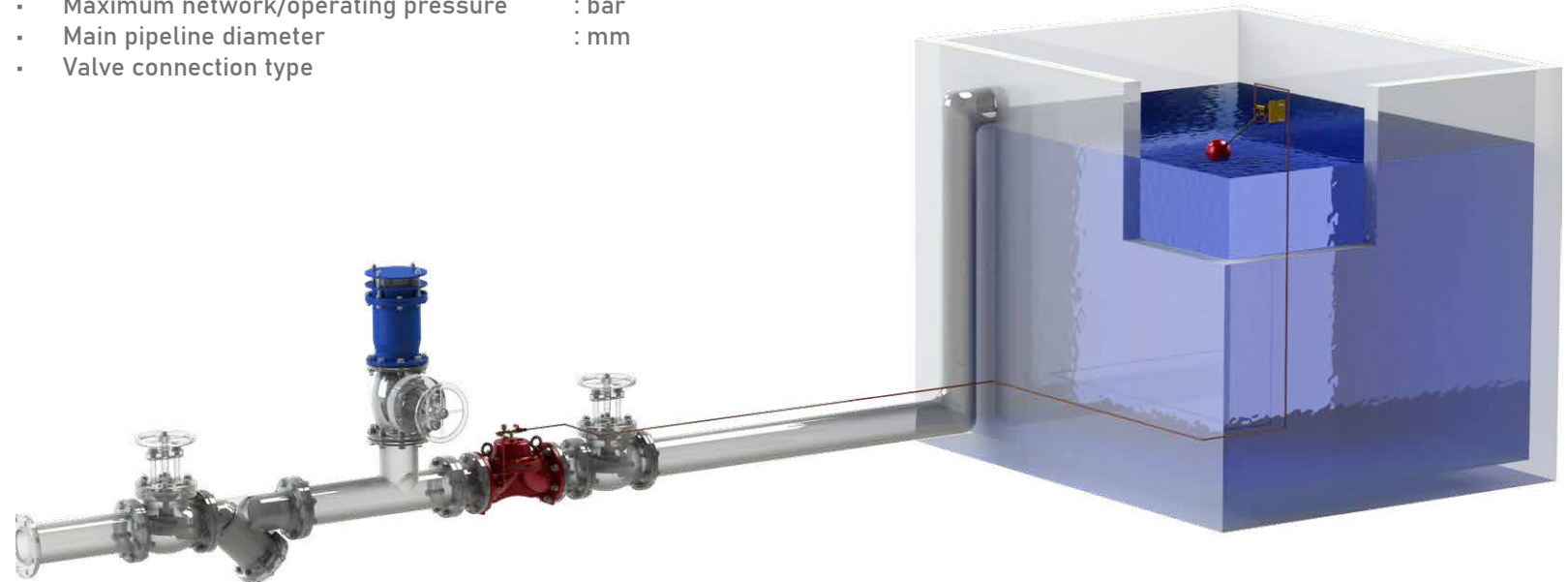

Hydraulic Control *Valves*

Differential Float Level Control Valve



Differential Float Level Control Valves are hydraulically controlled valves that precisely monitor and automatically balance the level in water tanks. The main valve is controlled via a differential float system, maintaining constant control of the tank water level between maximum and minimum limits. When the water level reaches maximum, the valve closes without impact. If the level drops, it opens automatically, ensuring the tank remains full.

A needle valve is used to adjust the valve's opening and closing speed, contributing to precise and balanced system operation. Differential Float Level Control Valves can be installed horizontally or vertically and can be integrated with electric float systems when necessary. Their robust construction, long-lasting sealing performance, and precise control capabilities ensure reliable level control in water storage and transmission systems.

Order Information

Please provide the following information in case of order

- Maximum flow rate : m³/h
- Maximum network/operating pressure : bar
- Main pipeline diameter : mm
- Valve connection type
- Required level control range : m

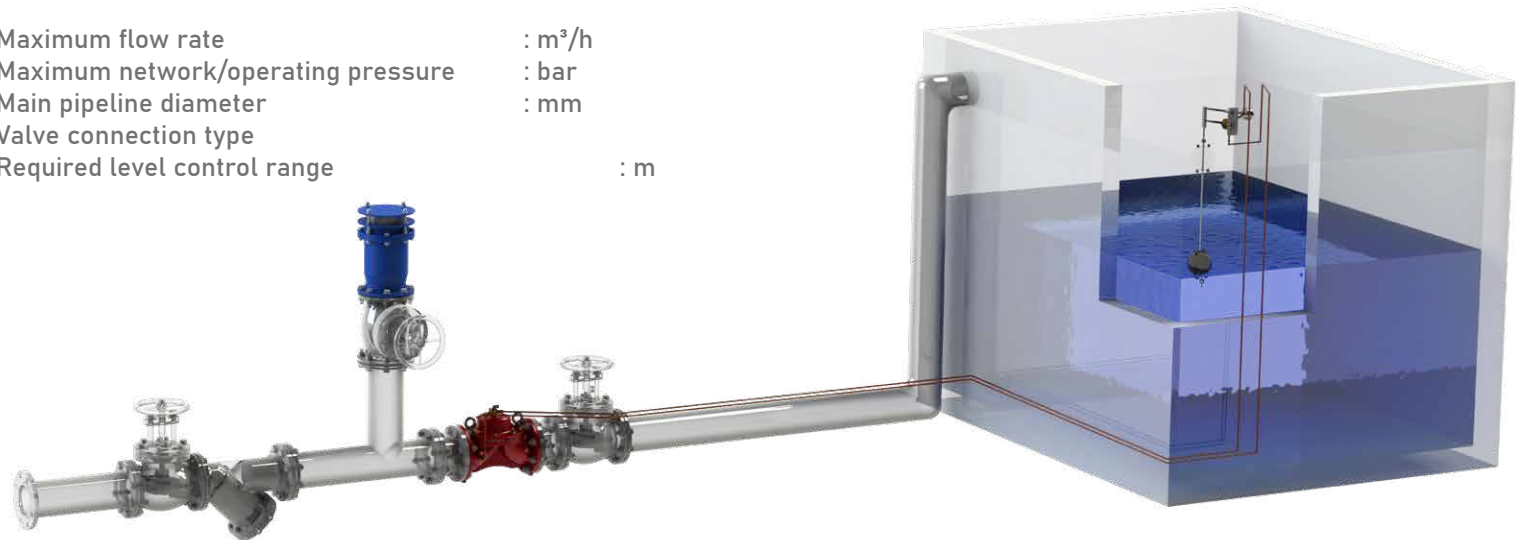

Hydraulic Control Valves

Electric Float Level Control Valve



Electric Float Level Control Valves are hydraulically controlled valves that continuously monitor and automatically regulate the water level within the tank using an electric float. When the water level in the tank falls below a predetermined minimum level, the electric float sends a signal to the solenoid coil on the main valve. This signal then fully opens the valve, ensuring the tank remains full and contributing to uninterrupted system operation.

When the water level reaches the maximum level, the electric float sends a signal back to the solenoid coil, closing the valve without impact. The valve can be installed horizontally or vertically. With its durable body, long-lasting seals, and precise control capabilities, Electric Float Level Control Valves provide reliable level management in water storage and transmission systems.

Order Information

Please provide the following information in case of order

- Maximum flow rate : m³/h
- Maximum network/operating pressure : bar
- Main pipeline diameter : mm
- Valve connection type
- Voltage to be used : volts

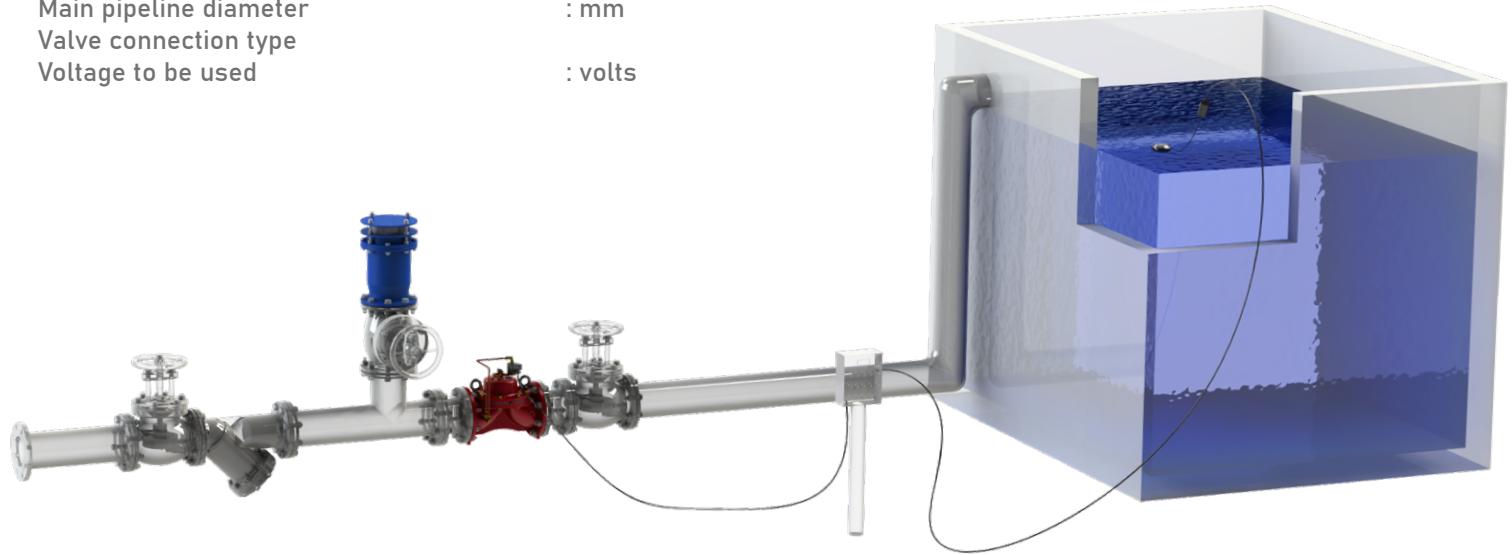

Hydraulic Control Valves

Hydraulic control valves are fundamental components that automatically control the pressure, flow rate, and direction of water in fluid systems, ensuring the system operates safely and efficiently. They manage the flow by operating on pressure differentials within the system without requiring electrical or mechanical intervention. Thanks to these features, hydraulic control valves save energy while also increasing the stability and durability of the system.

The main function of these valves is to regulate the flow of water under the desired conditions. They perform functions such as pressure reduction, pressure stabilisation, flow control, level control, and prevention of sudden closure or opening. They also protect against sudden pressure changes that may occur in the system, safeguarding the pipeline and other equipment. Thus, hydraulic control valves are central to both automation and system safety.

Different types of hydraulic control valves have been developed for different purposes. Pressure reducing valves maintain constant pressure in the line, protecting the equipment. Pressure relief valves secure the system in cases of excessive pressure. Flow control valves balance the flow rate of water, while level control valves automatically maintain the desired water level in reservoirs. Furthermore, soft-opening/closing valves minimise vibration and noise in the system by preventing water hammer.

Hydraulic control valves have a wide range of applications, from agricultural irrigation systems to drinking water networks, industrial facilities to firefighting lines. Thanks to their automatic operation capabilities, they are preferred in systems where energy efficiency and operational safety are paramount. At TAYFUR WATER SYSTEMS, we offer the most reliable solutions for water management by manufacturing durable and precise hydraulic valves suitable for different operating conditions.

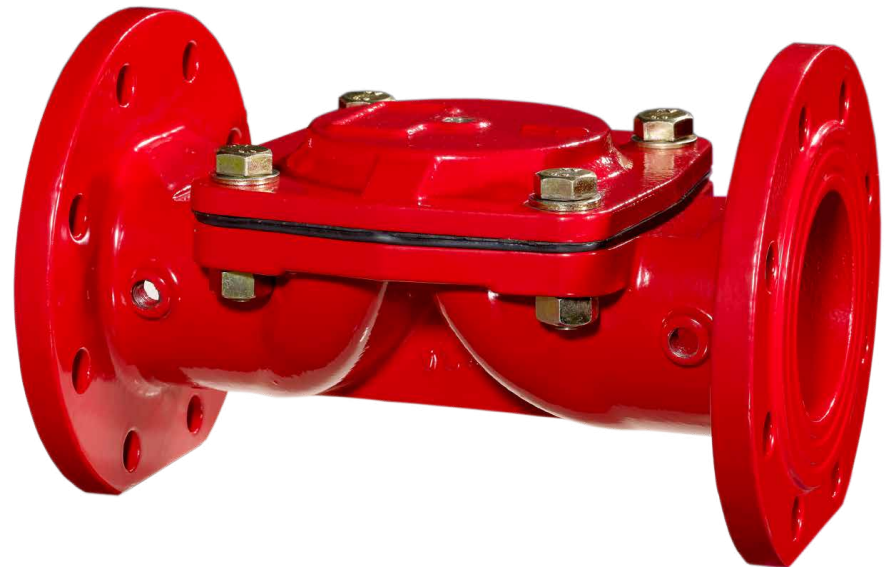

Hydraulic Control Valves

Varieties

- PR** Pressure Reducing Control Valve
- QR** Quick Relief Control Valve
- HD** Hydraulic Check Valve
- FL** Float Level Control Valve
- FLEL** Electric Float Level Control Valve
- DIFL** Differential Float Level Control Valve



®
TAYFUR
H00N

Hydraulic Control Valves

Current Diameters

Flanged	mm	50	65	80	100	125	150	200	250	300
	inch	2	2½	3	4	5	6	8	10	12
Threaded	mm	20	25	32	40	50	65	80		
	inch	¾	1	1¼	1½	2	2½	3		
Victaulic	mm	50	65	80	100	150	200			
	inch	2	2½	3	4	6	8			
Angle (Flanged / Threaded)	mm	50	80	100	150					
	inch	2								

Material : GGG40

Body : Globe

Transmission Pressure : PN10 - PN16 - PN25

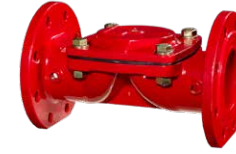

Working Principles

Hydraulic control valves are components that perform automatic opening, closing, or modulation (partial opening/closing) operations using the pressure of the fluid in the system. These valves operate using the existing line pressure in the system without requiring an external energy source. Hydraulic control valves, typically diaphragm or piston-type, are controlled by pilot valves, pressure regulators, or electromechanical control elements routed through control lines.

The pressure difference applied to the diaphragm or piston chamber within the valve's main body determines the valve's opening position. This allows the flow to be maintained at fully open, fully closed, or partially open, depending on system needs.

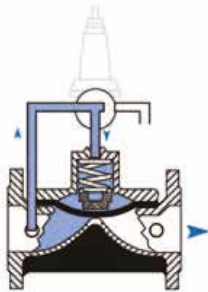

Valve Closing Mode (Close Mode)

In valve closing mode, line pressure is applied to the upper chamber of the diaphragm or piston. When pressurized water is directed into the upper chamber, this pressure force, combined with the valve spring, forces the main valve against its seating surface. This completely shuts off the valve flow and isolates the relevant system line.

Closing is generally performed for system safety, maintenance requirements, or control purposes. In this mode, the valve can be set to close quickly or gradually using a pilot system.

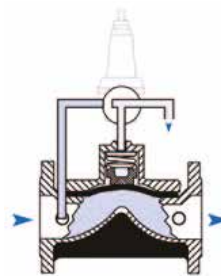

Valve Opening Mode (Open Mode)

In open mode, the pressure in the upper chamber of the valve diaphragm or piston is reduced via the discharge line or control pilot. When the pressure in the upper chamber decreases, the main damper moves upward under the influence of line pressure, opening the valve. This allows fluid to flow freely through the valve.

The opening process can be initiated manually, automatically, or remotely, depending on the system's flow demand. The opening speed can be controlled via pilot valves or needle valves to achieve the desired flow rate.

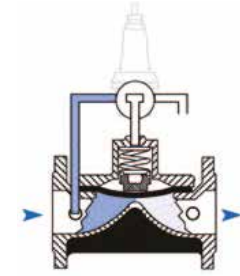

Modulating Mode

In modulating mode, the valve continuously controls flow by operating in a balanced manner between fully open and fully closed positions. This mode is used to maintain constant parameters such as system pressure, flow rate, or level.

Modulating control is typically achieved with proportional pilot valves or sensor-assisted control units. The pressure on the diaphragm is continuously adjusted by the pilot system to optimize valve opening. This increases system stability, prevents sudden pressure fluctuations, and improves energy efficiency.

Dimensions and Weights

Flanged

DN		D		L		H		Weight	
inch	mm	inch	mm	inch	mm	inch	mm	Lbs	Kg
2	50	6,50	165	8,66	220	5,87	149	17,60	8,00
2½	65	7,28	185	8,66	220	6,06	154	21,60	9,80
3	80	7,87	200	11,26	286	6,81	173	38,80	17,46
4	100	8,66	220	12,99	330	6,81	173	46,47	29,08
5	125	9,84	250	14,49	368	8,35	212	62,30	28,25
6	150	11,22	285	15,51	394	12,80	325	114,40	51,90
8	200	13,38	340	18,19	462	14,96	380	200,80	91,10
10	250	15,94	405	21,46	545	19,09	458	332,90	151,00
12	300	18,11	460	22,19	582	19,69	500	392,90	178,20

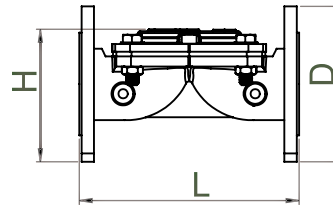

Threaded

DN		D		L		H		Weight	
inch	mm	inch	mm	inch	mm	inch	mm	Lbs	Kg
3/4	20	0,90	23,0	5,2	132	2,0	50,0	2,2	1,00
1	25	0,90	23,0	5,2	132	2,0	50,0	2,2	1,00
1¼	32	1,35	34,0	6,8	173	3,6	92,3	6,3	2,85
1½	40	1,35	34,0	6,8	173	3,6	92,3	5,8	2,65
2	50	1,65	41,5	7,3	186	4,4	112,0	9,0	4,10
2½	65	1,80	46,0	8,9	226	4,6	118,0	11,7	5,30
3	80	2,05	52,5	12,5	318	5,0	127,0	26,4	12,00

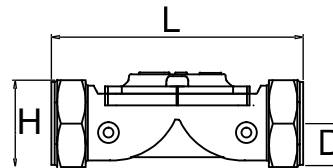

Dimensions and Weights

Victaulic

DN		D		L		H		Weight	
inch	mm	inch	mm	inch	mm	inch	mm	Lbs	Kg
2	50	1,18	30	7,24	190	3,11	79,0	8,60	3,9
2½	65	1,46	37	8,90	218	3,74	95,0	9,92	4,5
3	80	1,77	45	11,42	290	3,70	94,0	13,00	5,9
4	100	2,26	57,5	12,48	317	4,19	106,5	13,6	6,2
6	150	3,30	84	17,87	392	5,24	133,0	66,00	30
8	200	4,53	115	21,40	544	13,10	332,0	143,30	65

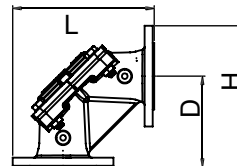
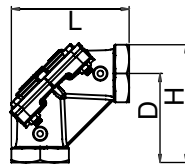
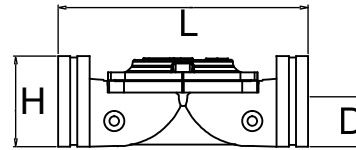

Angeled (Threaded / Flanged)

	DN		D		L		H		Weight	
	inch	mm	inch	mm	inch	mm	inch	mm	Lbs	Kg
Threaded	2	50	4,4	112	6,05	154	6,05	154	9,47	4,3
	3	80	7,1	180	9,45	240	9,45	240	29,30	13,3
Flanged	2	50	4,40	112	7,44	189	7,44	189	19,07	8,65
	3	80	7,10	180	10,95	278	10,95	278	39,02	17,7
	4	100	7,48	190	12,00	305	12	305	60,19	27,3
	6	150	9,05	230	14,92	379	14,92	379	106,26	48,2

Main Components

Flanged

Nr.	Material Name	Material Type
1	Body	GGG40
2	Diaphragm	Natural Rubber
3	Spring Wedge	Polyamide
4	Spring	SST 302
5	Cover	GGG40
6	Washer	8.8 Coated Steel
7	Bolt	8.8 Coated Steel
8	Eyebolt	8.8 Coated Steel
9	Nut	8.8 Coated Steel

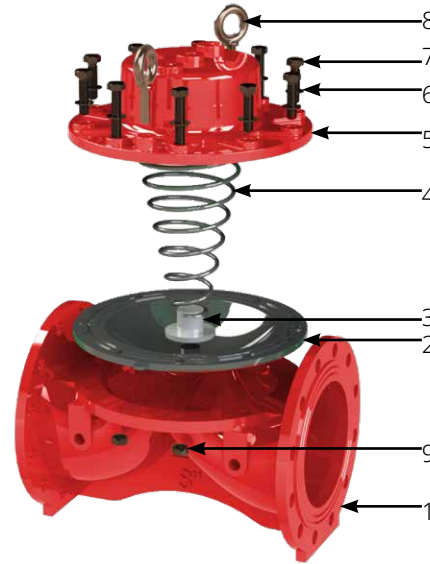

Threaded - Victaulic - Angled

Nr.	Material Name	Material Type
1	Body	GGG40
2	Diaphragm	Natural Rubber
3	Spring Wedge	Polyamide
4	Spring	SST 302
5	Cover	GGG40
6	Washer	8.8 Coated Steel
7	Bolt	8.8 Coated Steel
8	Nut	8.8 Coated Steel

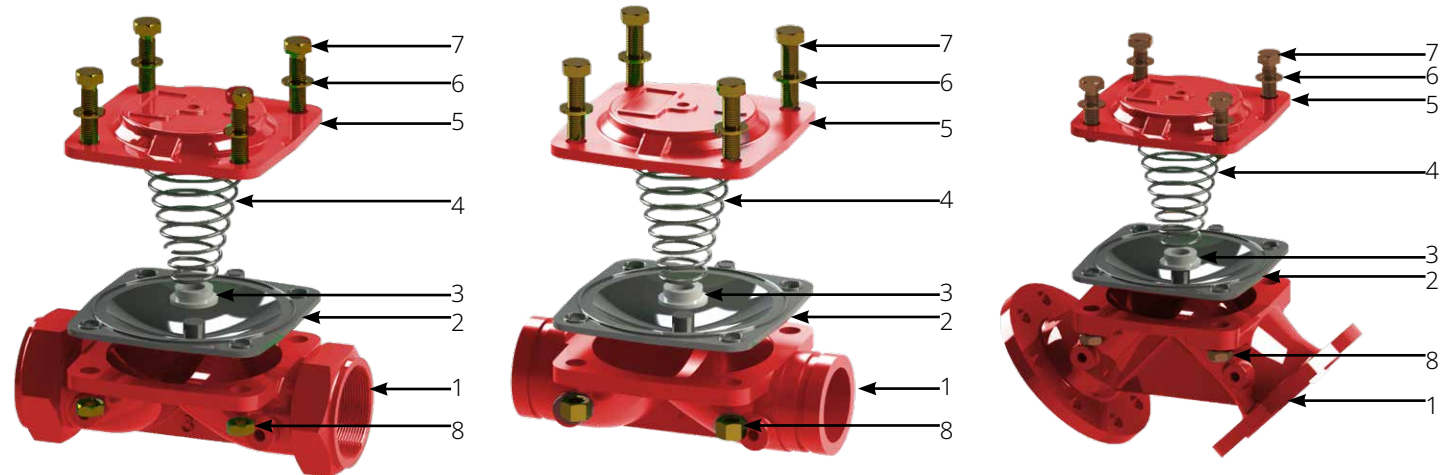

Technical Specifications

Working Pressure	Standard	0.7 - 16 bar (10 - 240 psi)
	Low Pressure Range	0.5 - 10 bar (7.5 - 160 psi)
	High Pressure Range	1 - 25 bar (14.5 - 360 psi)
Temperature	Minimum Operating Temperature	- 10 °C (14 °F) DIN 2401/2
	Maximum Operating Temperature	80 °C (176 °F) DIN 2401/2
Connection	Flanged	DIN 2501, ISO 7005 - 2
	Threaded	ISO (BSP), ANSI (NPT)
Coating	Standard	Epoxy
	Optional	Polyester
Hydraulic Connections	Standard	Reinforced Nylon (Air Brake) Hydraulic Tubing SAE J 844
	Optional	DIN1057
Actuator Type	Single Control Chamber Diaphragm Aperture	

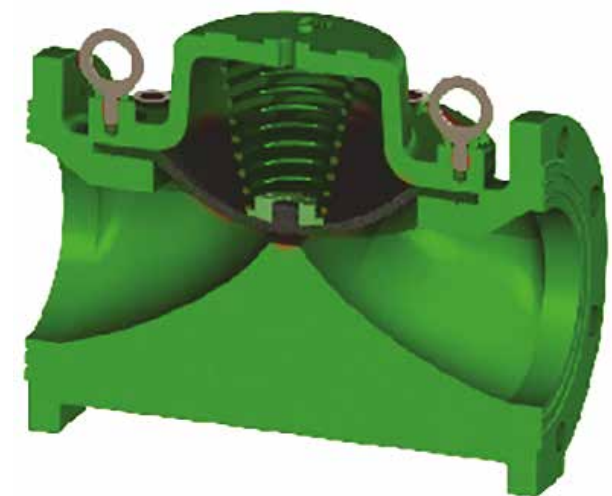

Hydraulic Performance

	inch	mm	inch	mm	inch	mm	inch	mm	inch	mm	inch	mm	inch	mm	inch	mm	inch	mm
Valve Diameter	2	50	2½	65	3	80	4	100	5	125	6	150	8	200	10	250	12	300
Kv m ³ /h @ 1bar	88		88		174		187		187		419		1139		1698		2276	
Cv gmp @ 1psi	102		102		201		216		216		484		1316		1961		2629	

$$Kv(Cv) = Q \cdot \sqrt{G/\Delta P}$$

Kv : Valve Flow Coefficient (Flow rate at 1 Bar Pressure Loss m³/h @ 1 Bar)
Cv : Valve Flow Coefficient (Flow Rate at 1 Psi Pressure Loss Gpm @ 1 Psi)
Q : Flow (m³/h, gpm)

Cv = 1,155Kv
ΔP : Pressure Loss(bar, psi)
G : Specific Gravity of Water (Water=1.0)

Pressure Loss Table

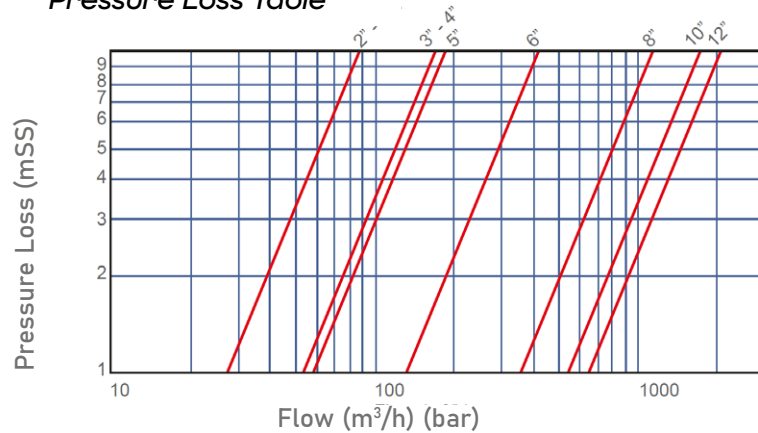

Cavitation Table

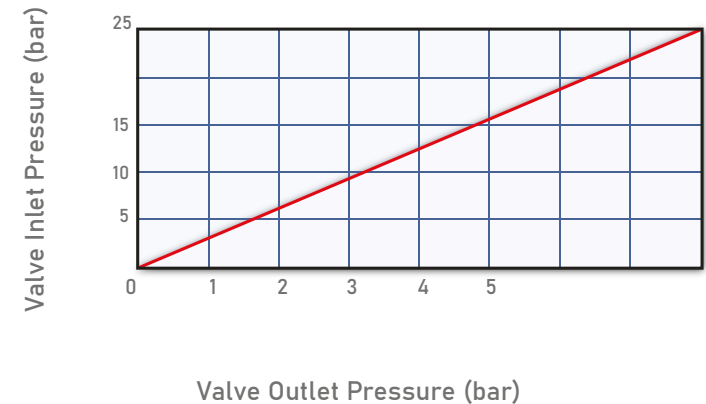

Trade Fairs





Kemalpaşa OSB Mahallesi Kuzey Sanayi Caddesi
Dış Kapı No:13
Kemalpaşa / İzmir

+90 232 458 49 99
+90 232 458 57 67

TYPHOON®

www.tayfursu.com.tr | info@tayfursu.com.tr

Her
Fabrika
Bir
Kaledir*

H. Atatürk



* Every factory is a fortress